

<http://www.anysvc.net/> ICQ: 343183001 QQ: 35070846 MSN: AnySVC@hotmail.com

Charger Connector

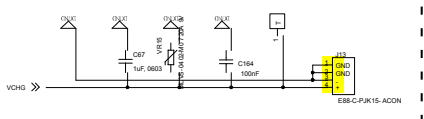

Battery Connector

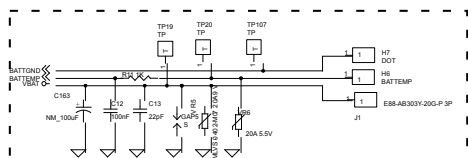

Test Point

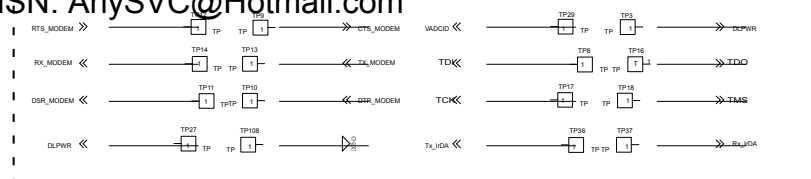

Battery OVP Circuit

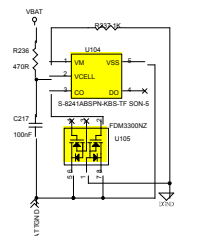

Charging Circuit

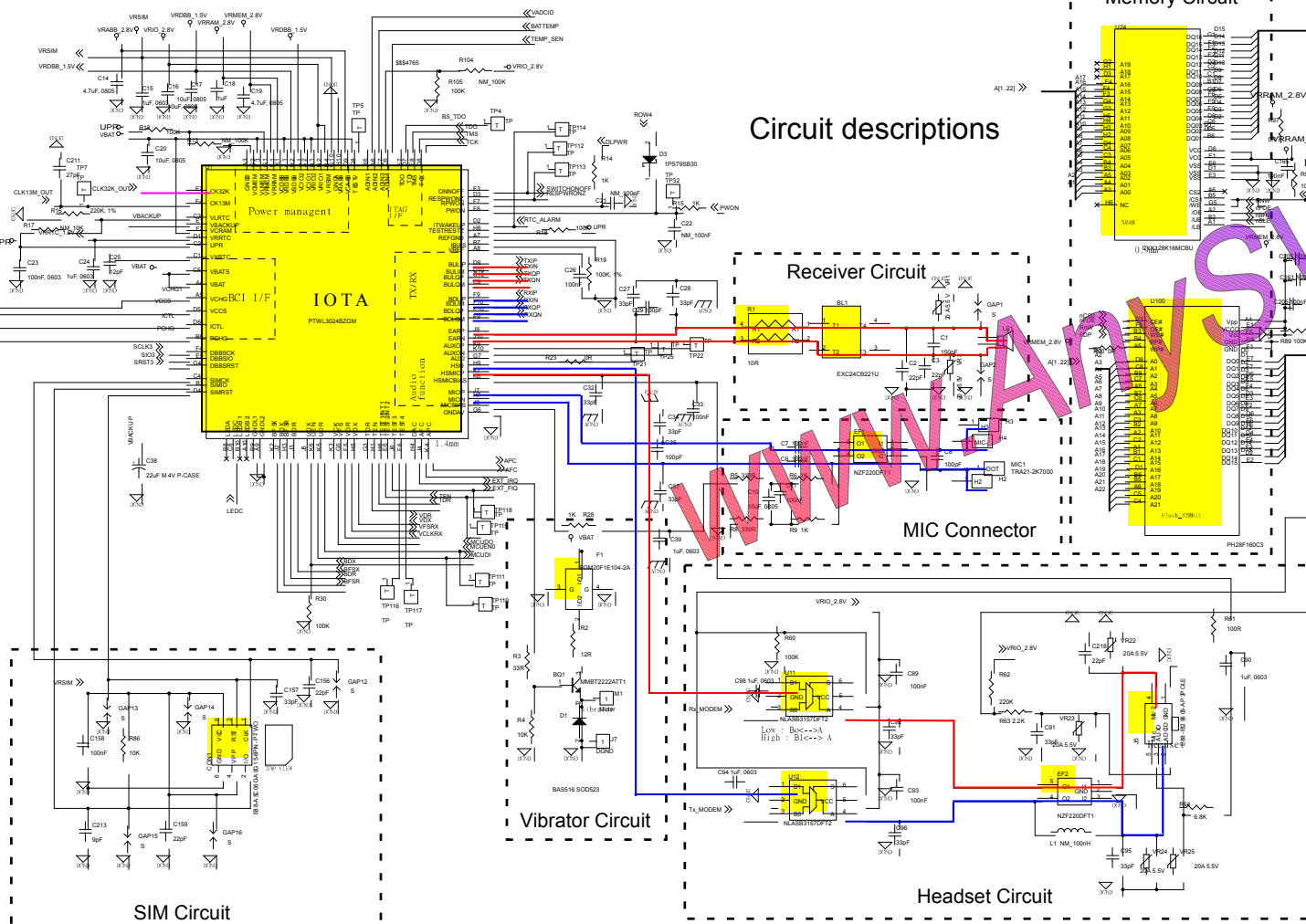
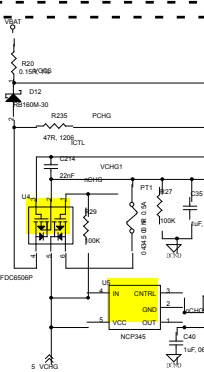

Circuit descriptions

Memory Circuit

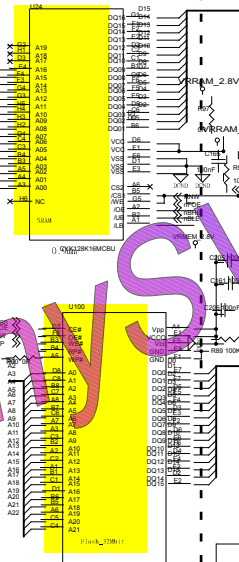

Receiver Circuit

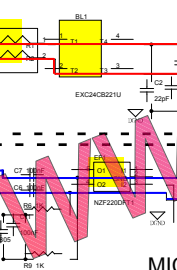

MIC Connector

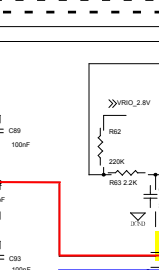

Vibrator Circuit



Headset Circuit



SIM Circuit

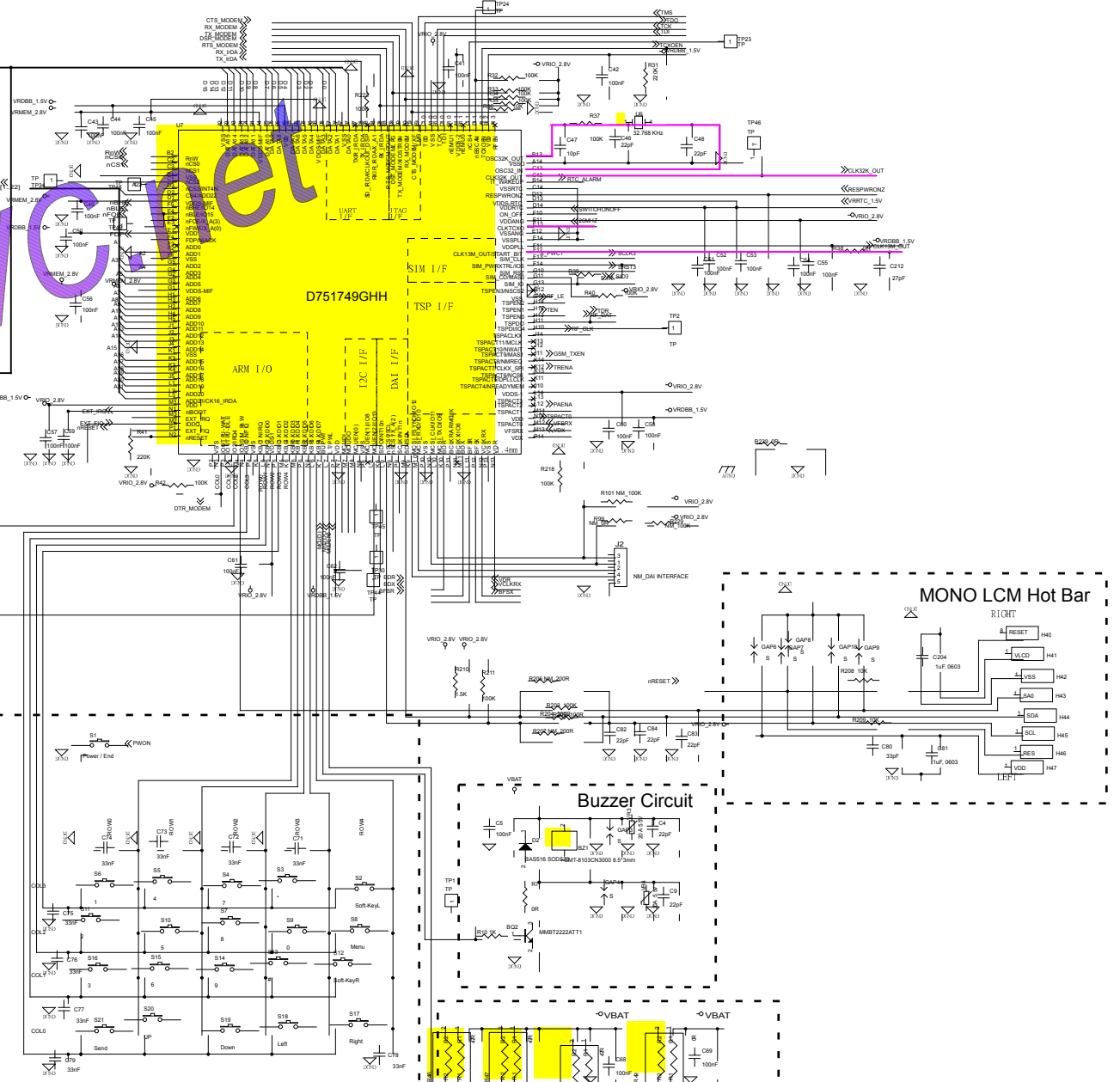

MONO LCM Hot Bar

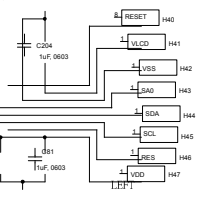

Buzzer Circuit

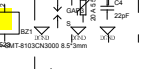

Keypad Circuit

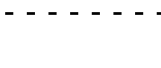

Backlight LED

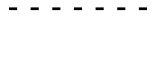

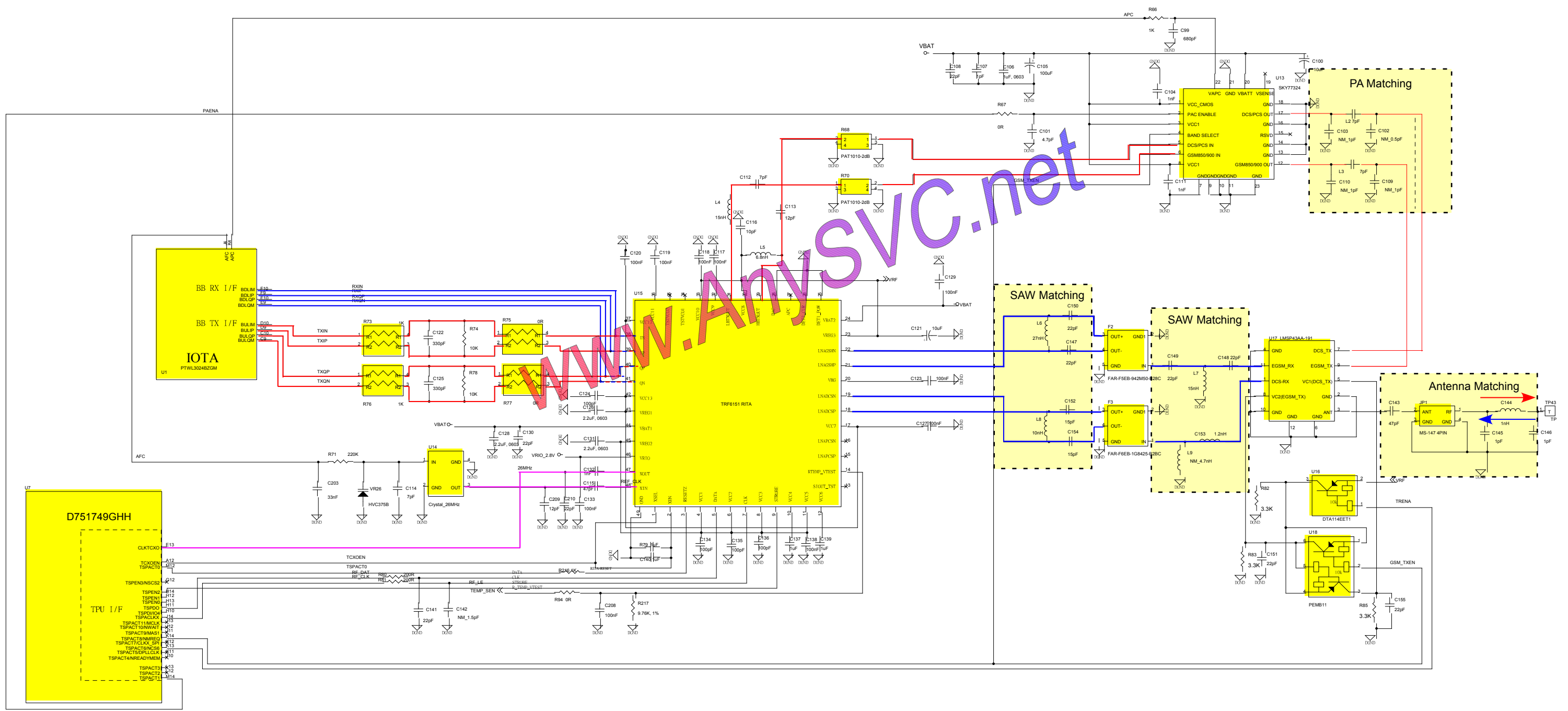

Fortune EU band

Keypad
Function

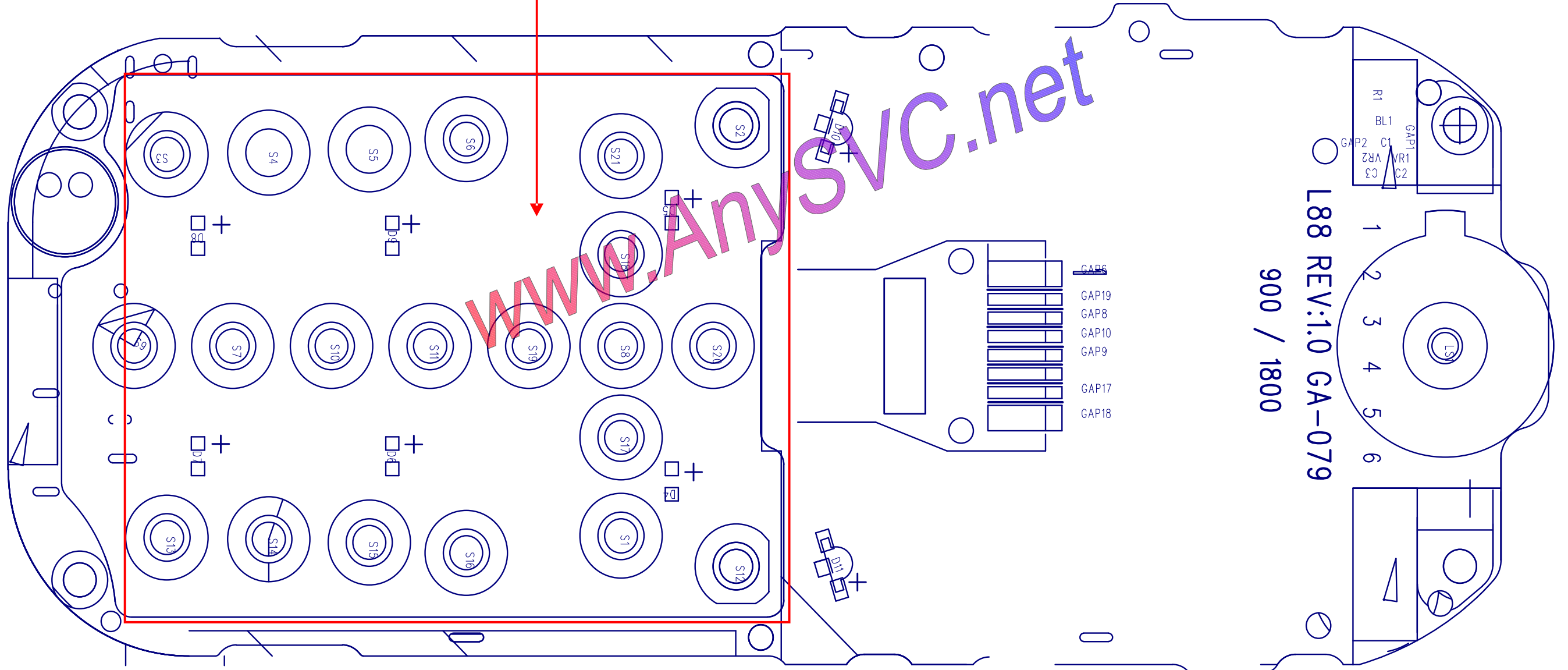

900 / 1800

L88 REV:1.0 GA-079

EU Band

TOP

SAW Filter

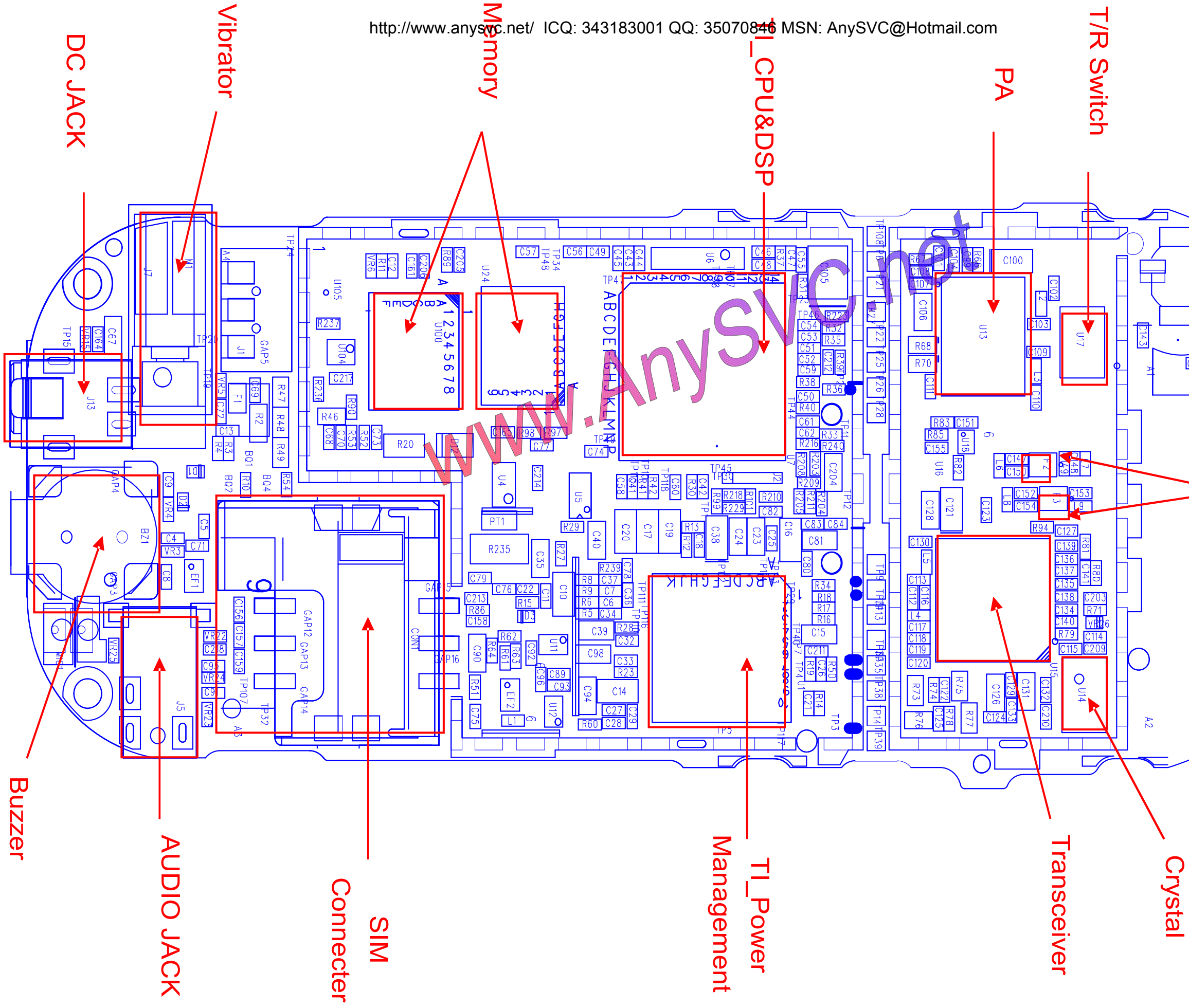

<http://www.anysvc.net/> ICQ: 343183001 QQ: 35070846 MSN: AnySVC@Hotmail.com